

Report Prepared On: 02/01/13

Structured Product Details

Name	Notes linked to the S&P 500 Index
Issue Size	\$1.00 million
Issue Price	\$1,000
Term	72 Months
Annualized Coupon	0.00%
Pricing Date	September 28, 2011
Issue Date	September 30, 2011
Valuation Date	September 28, 2017
Maturity Date	October 3, 2017
Issuer	Barclays
CDS Rate	223.06 bps
Swap Rate	1.49%
Reference Asset	the S&P 500 Index
Initial Level	1,151.06
Dividend Rate	2.24%
Implied Volatility	27.76%
Delta¹	0.25
Fair Price at Issue	\$921.77
CUSIP	06738KWV9
SEC Link	www.sec.gov/Archives/edgar/data/312070/000119312511259746/d238562d424b2.htm

Related Research

Research Papers:

www.slcg.com/research.php

- "Are Structured Products Suitable for Retail Investors?" December 2006.
- "Structured Products in the Aftermath of Lehman Brothers," November 2009.
- "What TiVo and JP Morgan Teach Us about Reverse Convertibles," June 2010.

Tim Dulaney, Ph.D.,
 Senior Financial Economist, SLCG
 (+1) 703.539.6777
TimDulaney@slcg.com

Notes linked to the S&P 500 Index

Description

Barclays issued \$1.00 million of Notes linked to the S&P 500 Index on September 30, 2011 at \$1,000 per note.

This Principal Protected Note (PPN) does not pay periodic coupons, but instead pays a single amount at maturity depending on the final level of the S&P 500 Index. It is called 'principal protected' because the minimum payout of the note at maturity is the initial issue price, so long as Barclays does not default.

If the S&P 500 Index on September 28, 2017 is lower than or equal to 1,151.06, investors receive the principal of the notes, \$1,000. If the S&P 500 Index on September 28, 2017 is higher than 1,151.06, in addition to the \$1,000 principal, investors will receive a return equal to the percentage increase, above 1,151.06, in the S&P 500 Index, up to a maximum of 80.00%.

Valuation

This PPN linked to the S&P 500 Index can be valued as a combination of a zero-coupon note from Barclays, one long at-the-money call option on the the S&P 500 Index, and one short out-of-the-money call option on the the S&P 500 Index. For reasonable valuation inputs this note was worth \$921.77 when it was issued on September 30, 2011, because the value of the options investors gave Barclays plus the interest investors would have received on Barclays's par debt was worth \$78.23 more than the options investors received from Barclays.

There is no active secondary market for most structured products. Structured products, including this note, therefore are much less liquid than simple stocks, bonds, notes and mutual funds. Investors are likely to receive less than the structured product's estimated market value if they try to sell the structured product prior to maturity. Our valuations do not incorporate this relative lack of liquidity and therefore should be considered an upper bound on the value of the structured product.

Payoff Curve at Maturity

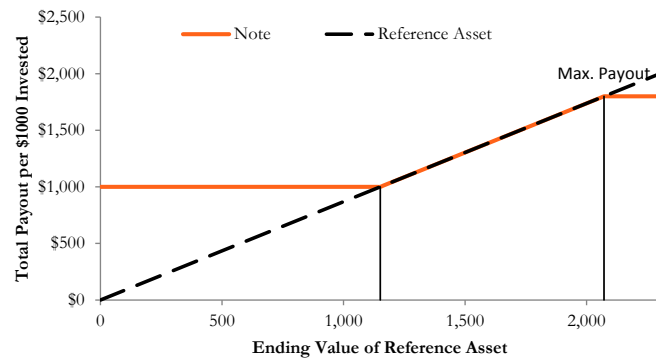

The payoff diagram shows the final payoff of this note given the S&P 500 Index level (horizontal axis). For comparison, the dashed line shows the payoff if you invested in the S&P 500 Index directly.

Principal Payback Table

The S&P 500 Index	Note Payoff
0.00	\$1,000.00
115.11	\$1,000.00
230.21	\$1,000.00
345.32	\$1,000.00
460.42	\$1,000.00
575.53	\$1,000.00
690.64	\$1,000.00
805.74	\$1,000.00
920.85	\$1,000.00
1,035.95	\$1,000.00
1,151.06	\$1,000.00
1,266.17	\$1,100.00
1,381.27	\$1,200.00
1,496.38	\$1,300.00
1,611.48	\$1,400.00
1,726.59	\$1,500.00

Maturity Payoff Diagram

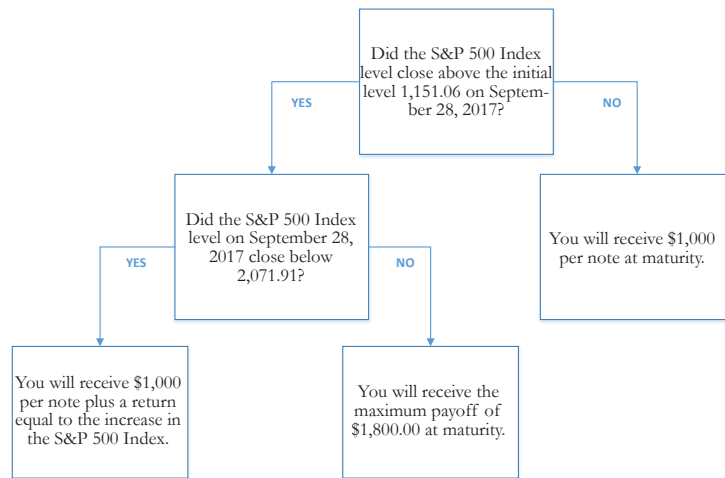

The contingent payoffs of this Note.

Analysis

“Principal protected” is a misleading label previously used to refer to structured products that pay at least the note’s face value at maturity if the issuer does not default. Investors purchasing these PPN notes effectively purchase zero-coupon notes and at-the-money call options, and sell out-of-the-money call options, posting the note’s issue price as collateral. That is, investors in these notes receive the payoffs to call options in lieu of interest coupon payments. This PPN note is fairly priced if and only if the net value of the options investors exchanged with Barclays equals the value of interest Barclays pays on its straight debt.

Barclays’s Stock Price

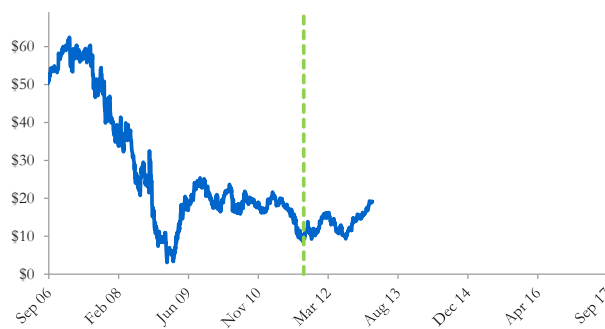

The graph above shows the adjusted closing price of the issuer Barclays for the past several years. The stock price of the issuer is an indication of the financial strength of Barclays. The adjusted price shown above incorporates any stock split, reverse stock split, etc.

Barclays's CDS Rate

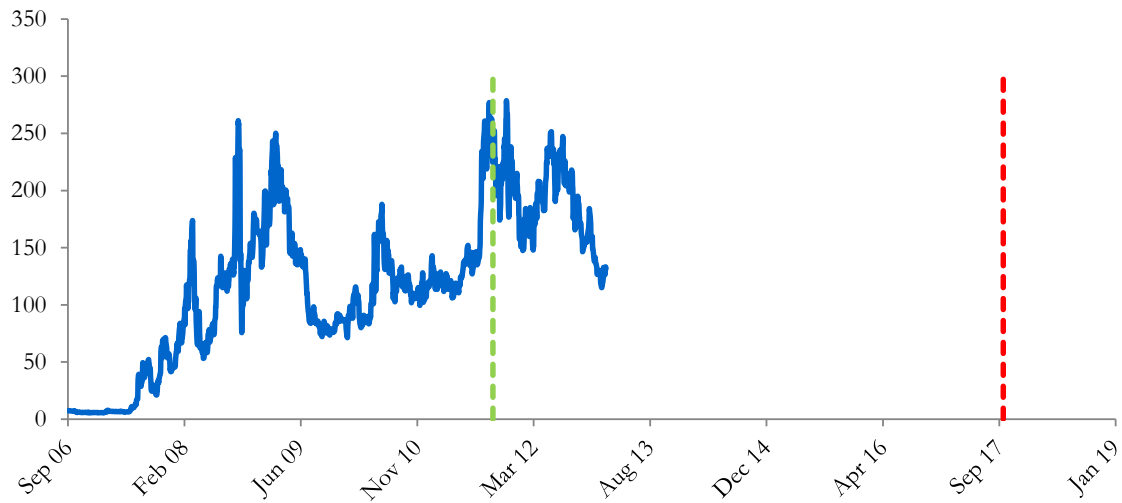

Credit default swap (CDS) rates are the market price that investors require to bear credit risk of an issuer such as Barclays. CDS rates are usually given in basis points (bps). One basis point equals 0.01%. Higher CDS rates reflect higher perceived credit risk, higher required yields, and therefore lower market value of Barclays's debt, including outstanding Note. Fluctuations in Barclays's CDS rate impact the market value of the notes in the secondary market.

The S&P 500 Index Level

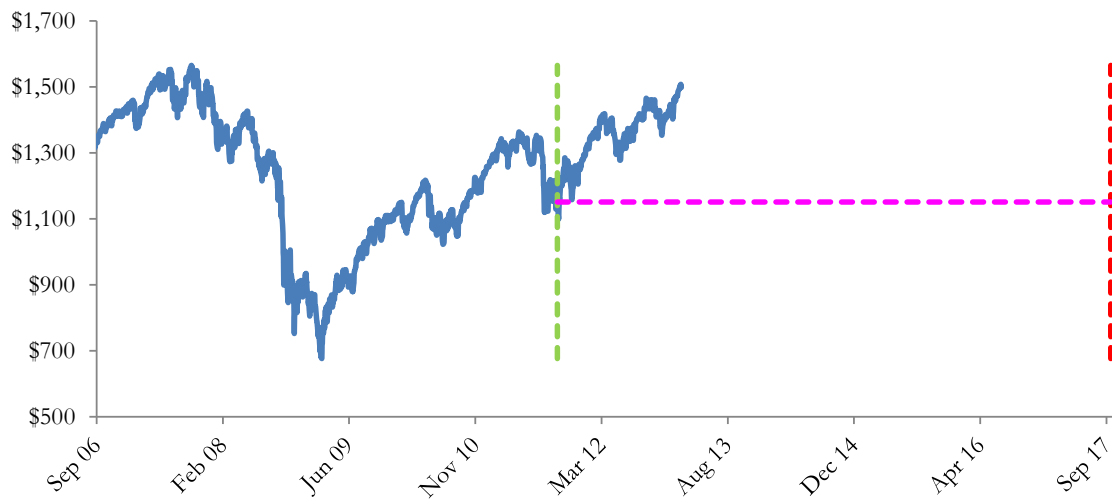

The graph above shows the historical levels of the S&P 500 Index for the past several years. The final payoff of this note is determined by the S&P 500 Index level at maturity. Higher fluctuations in the S&P 500 Index level correspond to a greater uncertainty in the final payout of this Note.

Realized Payoff

This product will mature on October 3, 2017.

Reference Asset The S&P 500 Index's Implied Volatility

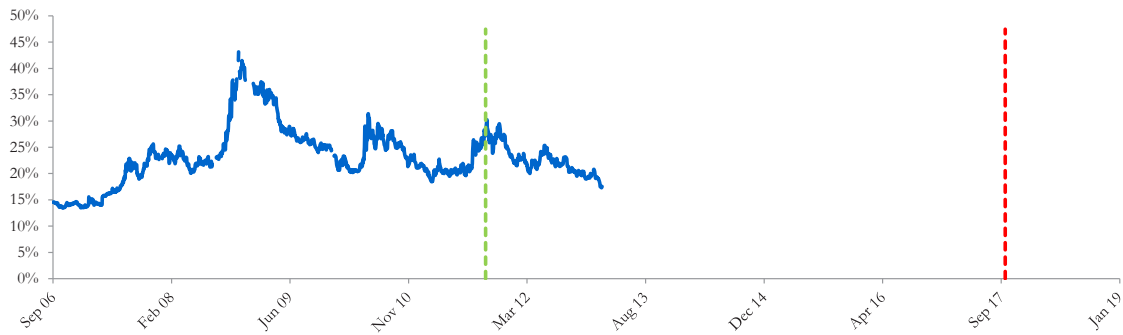

The annualized implied volatility of the S&P 500 Index on September 28, 2011 was 27.76%, meaning that options contracts on the S&P 500 Index were trading at prices that reflect an expected annual volatility of 27.76%. The higher the implied volatility, the larger the expected fluctuations of the S&P 500 Index level and of the Note's market value during the life of the Notes.

Decomposition of this Note

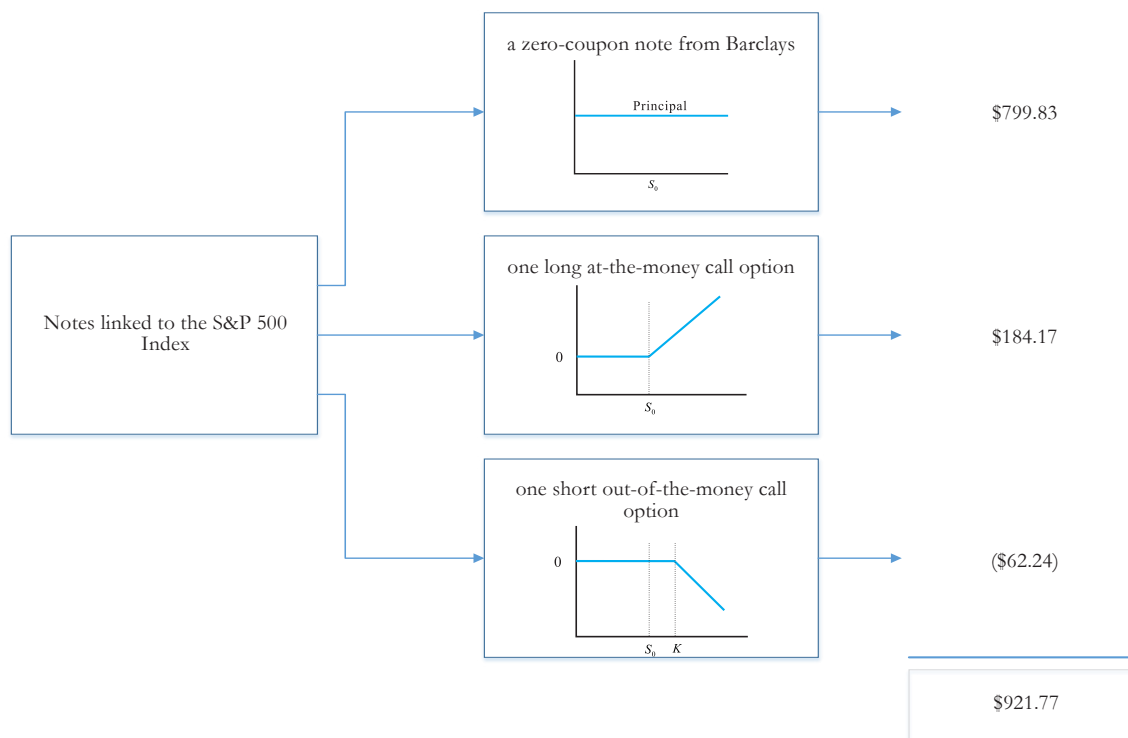

This note can be decomposed into different components, and each component can be valued separately. The chart above shows the value of each component of this Note.

1. Delta measures the sensitivity of the price of the note to the S&P 500 Index level on September 28, 2011.
2. CDS rates can be considered a measure of the probability that an issuer will default over a certain period of time and the likely loss given a default. The lower the CDS rate, the lower the default probability. CDS rate is given in basis points (1 basis point equals 0.01%), and is considered as a market premium, on top of the risk-free rate, that investors require to insure against a potential default.
3. Fair price evaluation is based on the Black-Scholes model of the S&P 500 Index on September 28, 2011.
4. Calculated payout at maturity is only an approximation, and may differ from actual payouts at maturity.
5. Our evaluation does not include any transaction fees, broker commissions, or liquidity discounts on the notes.